

Varenummer: 03449160
 Beskrivelse: Fluro Heavy Duty Ledleje GE 160 SWE
 Hul Ø160
 Note: 160

Mål

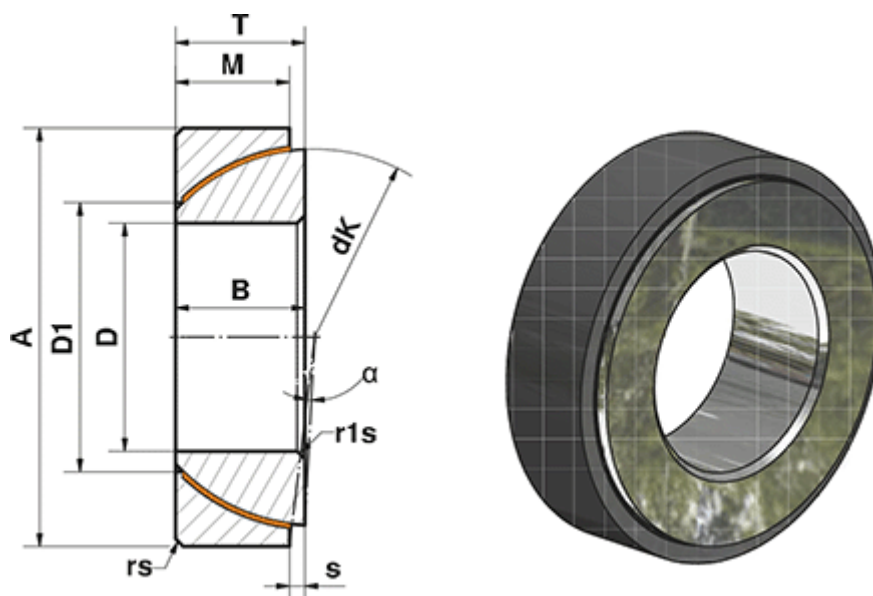

A	= 140	rs, r1s min	= 3
a (grader)	= 1	S	= 20
B	= 51	Statisk belastning C0 (kN)	= 4524
D	= 160	T	= 51
D1	= 182.4	Vægt (g)	= 9790
dK	= 225		
Dynamisk belastning C (kN)	= 2714		
M	= 49		